

ELLIET[®]

MANUAL

Minor 4S



This booklet provides information about the actual use and maintenance of the machine. **Read it carefully and keep it in a safe place for future reference.**



Please also keep your **purchasing invoice** or receipt together with this booklet.



Register your purchase online on **www.eliyet.eu**.



Attention: When putting a new machine into operation you must check the **tension of all of the blade bolts** during the first five working hours. Failure to do so may result in blades coming loose. This may cause serious consequential damage to your new machine and the operator is at risk of injuries or even death. ELIET cannot be held liable for any consequences of this negligence and it also voids any related warranty claim.

© ELIET

Copyright 2012 ELIET. All rights reserved. All textual material, drawings, illustrations, diagrams, graphs, etc., included in this ELIET booklet are protected by copyright and also by other intellectual property rights. None of this information may be copied for commercial purposes or distribution and/or changed or reposted for other purposes. The copyright on the content included in this ELIET manual remains the exclusive property of its respective owners.

1. Introduction



1.1 Read this operation manual carefully

ELIET machines are designed for safe and reliable use; this requires their operation in accordance with the instructions provided. Carefully read these operating instructions before using the machine. Failure to do so may result in personal injury or damage to the equipment.

1.2 Identification data - ELIET MINOR 4S

Copy the identification data of your machine into the text boxes:

Article number:	<input type="text" value="MA"/>
Serial number:	<input type="text"/>
Year of manufacture:	<input type="text" value="20"/>

2. Warranty



2.1 Warranty card

Whoever wishes to avail of the guarantee must **register his machine online**:

www.elietchines.com - Customer Support - Register.

If you do not have an internet connection available, you can also return the completed registration card to:

ELIET EUROPE NV, Diesveldstraat 2, B - 8553 Otegem (Belgium)

Tel. +32 56 77 70 88 - Fax +32 56 77 52 13

Read the warranty conditions on the attached warranty card.



For your information:

Any technical problems or defects that occur as a result of poor maintenance make the warranty null and void. Chapter 11 provides an overview of the maintenance intervals and recommendations regarding maintenance requiring the intervention of an authorised dealer.

3. Welcome



Welcome to the family of ELIET users.

We thank you for the trust that you have placed in ELIET and we are convinced that you have purchased the very best machine. The operating life of your ELIET machine depends on how you care for your machine. Strict adherence to the instructions and suggestions in these manuals will guarantee optimum performance of your ELIET machine for a very long time.

Read this manual carefully before operating the machine. This will prevent you from operating the device incorrectly. For your own safety, please observe the safety instructions specified in the relevant chapter. Even if you are thoroughly familiar with operating such equipment, it is still advisable to read these pages carefully.

All ELIET equipment and machines are continually being updated and improved and therefore the specifications of your machine may differ slightly in terms of shape, technology and accessories. The descriptions and technical data in this manual are accurate at the time of printing. Certain illustrations and descriptions may not apply to your specific machine, but instead relate to a different version of the machine. For this reason, discrepancies or deviations in the texts and illustrations in this manual cannot give rise to any claims, as you may well understand. If you still have questions after reading this manual, please contact your ELIET dealer.

You can find an official ELIET dealer near you at **www.elieta.eu**.

ELIET AT YOUR SERVICE

During office hours ELIET's help desk will make every effort to answer all of your questions:

European customers

GMT +1: from 8.00 am to 6.00 pm

Tel: +32 56 77 70 88

Fax: +32 56 77 52 13

Service@eliet.be

US customers

Ph (+001) 412 367 5185

Fax (+001) 412 774 1970

usinfo@elietusa.com

www.elietausa.com

4. Table of Contents

1. Introduction	3
1.1 Read this operating manual carefully	3
1.2 Identification data - MINOR 4S	3
2. Warranty	3
2.1 Warranty card	3
3. Welcome	4
4. Table of contents	5
5. Safety symbols	7
5.1 For your information	7
5.2 Attention.....	7
5.3 Warning	7
6. Main parts	8
6.1. Overall view.....	8
6.2 Engines	9
7. Safety instructions	11
7.1 Safety messages.....	11
7.2 Safety features	13
7.3 Safety instructions	14
7.3.1 General safety instructions.....	14
7.3.2 Careful and proper use	15
7.3.3 Operator's responsibilities	15
7.3.4 Personal protective equipment (PPE)	15
7.3.5 Danger zone.....	16
7.3.6 Periodic maintenance	17
7.3.7 Guidelines related to the electric machines	17
8. Dealer's duties	18
9. Operating instructions	20
9.1 Preliminary checks	20
9.2 Refuelling with petrol	21
9.3 Preparing the work site	22
9.4 Starting the engine	22
9.5 Stopping the engine.....	24
9.6 Operating the machine	25

9.5.1 Prior to starting the work	25
9.5.1 While working	25
9.5.2 After the engine stalls	26
10. Transporting the machine	28
11. Maintenance	30
11.1 General	30
11.2 Maintenance schedules	31
11.2.1 Lubricants	31
11.2.2 Special maintenance	31
11.2.3 Periodic maintenance schedule	32
11.3 Cleaning the machine.....	33
11.3.1 The importance of cleaning	33
11.3.2 What does cleaning entail?	34
11.4 Routine checks before each operation	35
11.4.1 Visual check	35
11.4.2 Engine oil level check	35
11.4.3 Cleaning the air filter	36
11.4.4 Sharpening the blades	36
11.4.5 Checking the belt tension.....	39
11.5 Maintenance after 20 hours of operation.....	40
11.5.1 Changing the oil	40
11.5.2 Checking and/or changing the spark plug	40
11.5.3 Changing the air filter	41
11.5.4 General lubrication treatment	41
11.5.5 Adjusting belt tension	42
11.5.6 Reversing and changing chipper blades	43
12. Storing the machine	46
13. Equipment specifications	47
14. CE Declaration of Conformity	48
B. Appendices	49
B1 Clearing the turbine	49
B2 Disassembling the blow chute	50
B3 List of torques	51
B4 Risk analysis.....	52
B5 Warranty conditions	53

5. Operator safety symbols

ELIET cannot anticipate every situation in which a risk or danger can occur. Therefore, the warnings in this operating manual and the labels on the machine are not comprehensive. Although minimal, some risk will always remain. If, as the operator of the machine, you use a working method or technique or perform any action that is not explicitly recommended by ELIET, ensure in any case that this will not present a danger for bystanders.



This manual uses certain symbols (“For your information”, “Caution”, “Warning”) to provide additional information and highlight dangers.

5.1 For your information



For your information:

This symbol is used to draw your attention to specific information and/or actions or to indicate where you can find additional information on the subject.

5.2 Caution



Caution:

This symbol suggests safe practices. The purpose is to prevent incorrect operation that could result in personal injury or damage to the machine.

5.3 Warning



Warning:

This notice warns you about extreme danger that you must be aware of in these specific circumstances.

So for the sake of your own safety, remain alert at all times.

These safety messages can only warn of, but not remove the danger. Using common sense and observing the guidelines contained in this manual are essential to prevent accidents.

6. Main parts

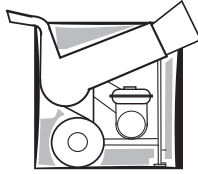

To fully understand the content of this operator's manual you need to be fully conversant with the terminology used for the descriptions. This chapter refers to a broad range of machine parts and identifies their names. We recommend that you take the time to study the machine prior to its use for a better understanding of the descriptions provided in this operating manual.

6.1 Overall view

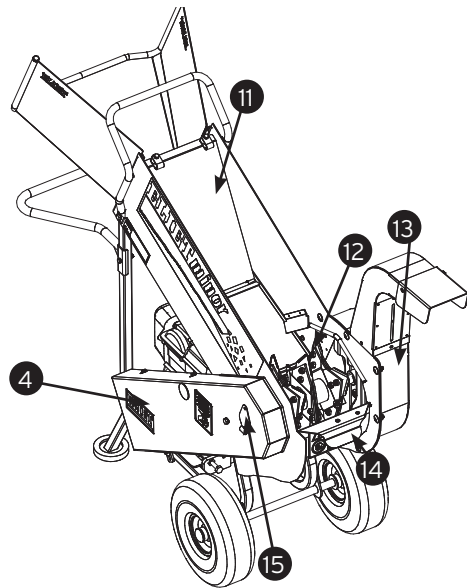
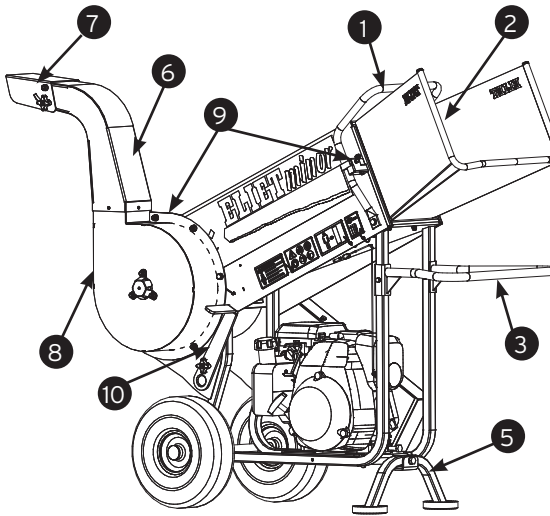

1) Emergency stop bar

2) Inlet funnel

3) Handlebar

4) Protective cover for driving mechanism

5) Balance base

6) Blow chute

7) Deflector valve

8) Turbine

9) Safety switches

10) Auxiliary tools

11) Anti-projection shield

12) Shredding chamber with blade axle

13) Impeller

14) Shredding chamber cover plate

15) Rotating point for auxiliary tools

6.2 Engines

6 hp HONDA GC190 -
6.5 hp HONDA GX200

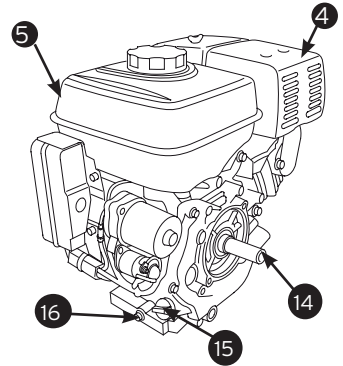
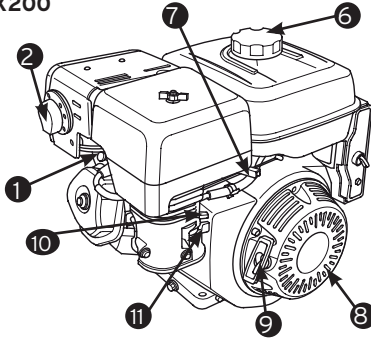

6.5 hp
VANGUARD

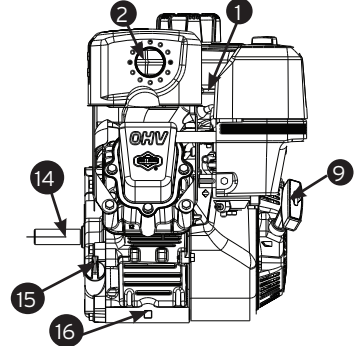
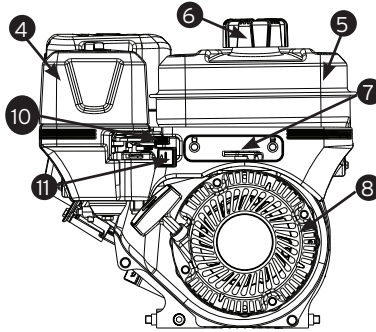

1. Spark plug
2. Exhaust
3. Silencer
4. Air filter
5. Petrol tank
6. Petrol cap
7. Speed control
8. Kickback starter
9. Starter handle
10. Choke

11. Fuel tap
12. Fuel supply
13. Carburettor
14. Engine axis
15. Oil dipstick and oil filler cap
16. Oil drainage plug
17. Engine serial number
18. Engine name label
19. Ignition lock engine

380 V ELECTRO ENGINE PROPELLING POWER

**For your information:**

All references to front, rear/back, left and right in this manual are from the viewpoint of the operator standing at the inlet of the machine.

**For your information:**

Your ELIET dealer remains at your service for any maintenance or advice, ensuring your ELIET machine is always in perfect condition. You can contact him for original ELIET parts and lubricants at any time. These service parts are manufactured according to the same strict rules and craftsmanship as the original equipment. (Find a dealer near you at www.eliyet.eu)

**Caution:**

For your own safety, only genuine parts should be mounted on ELIET machines. For a list of original spare parts and their ordering codes please visit www.eliyet.eu.

7. Safety instructions



7.1 Safety messages

The safety messages are clearly indicated on the machine with stickers or relief pictograms. Please take good notice of the symbols and warning messages displayed.

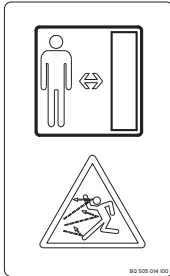

This sticker is affixed to the deflector valve and warns about the danger of injuries when one is standing in the discharge area while the machine is working.



This sticker is affixed to the cover of the driving belt. It indicates the potential danger arising when the cover is removed while the engine is running. The machine may never be operated without the cover. The engine must be switched off before removing the cover at all times.

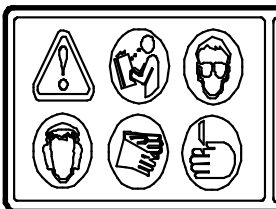

This sticker is glued to the side of the machine. It provides a summary of the general safety regulations by using icons:

1. The manual should be read and understood before operating the machine.
2. Suitable safety clothing (gloves, safety goggles, ear protection) must be worn when operating the machine.
3. Working with or performing maintenance on the machine involves a risk of cuts to the hands. Be alert and careful.

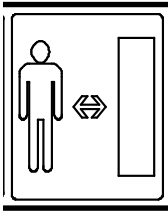

This sticker reminds the user that bystanders should observe a minimum distance (10 m) from the machine.

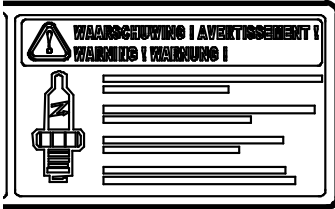

This sticker is affixed to the machine near the engine. It reminds the user to turn off the engine and remove the spark plug cap before starting maintenance on the machine.



This sticker is glued in the feed opening. It stresses the danger of cuts to hands inherent to wood chipping. It reminds the user how to safely operate the chipper. It is imperative never to reach beyond the safety shield!

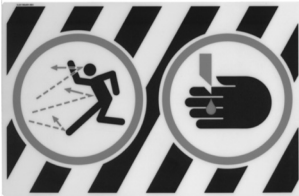

This sticker is glued to the safety shield. There is a real danger of cuts and injuries from flying chips when the safety shield is removed. This highly visual sticker draws special attention to these dangers.

7.2 Safety features

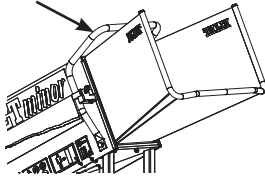

Emergency stop bracket:

This bracket is located around the feed opening. Pushing it back will stop the engine.

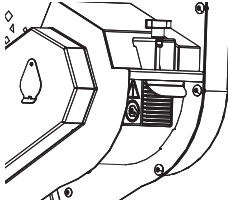

Shredding chamber cover plate:

This cover plate protects the user against injury from the blades when the engine is running. The engine stops automatically as soon as the star knob on the cover plate is loosened to open the cover.

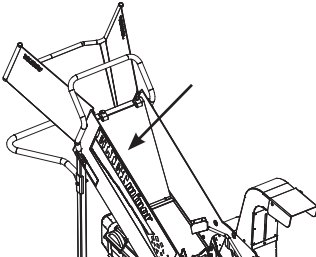

Safety shield:

The steel plate located in the feed opening protects the operator against flying wood chips. Placing one's hands beyond this steel plate is strictly prohibited.

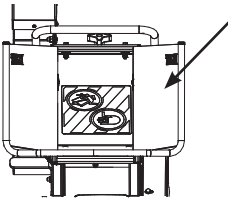

Feed hopper:

The hopper is mounted on the feed opening, pointing towards the operator. If, despite the warning, the user should reach beyond the protective shield, the obstruction formed by the hopper prevents easy access to the shredder compartment and makes injuries inflicted by the blades via the feed opening practically impossible.

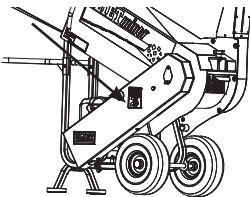

Belt protection cover:

The cover ensures that all the rotating parts of the driver mechanism that might cause injuries are adequately screened off.



Safety set:

For your safety, we strongly recommend using the supplied set of safety tools, consisting of safety goggles, ear protection and a pair of rigger gloves.

7.3 Safety instructions

7.3.1 General safety instructions

- The owner of the machine will keep this manual during its complete service life. A reference guide for the user, it also ensures that the machine is used and maintained correctly at all times. Always refer to this instruction manual if you have any doubts about an operation that you are about to perform.
- If any of the instructions in this manual are not clear to you, do not hesitate to contact your Eliet dealer for further explanation. In addition, the ELIET help desk is at your service during office hours to answer any questions you may have (EU +32 56 77 70 88).
- Be sure to read the chapter which is intended for the dealer (see Chapter 8) and verify whether the machine was delivered in accordance with the instructions.
- After you purchase the machine, always allow the dealer or a professional to instruct you regarding correct use.
- Carefully observe all safety instructions when using this ELIET machine! Carefully read all the instructions relating to the use of the machine. All of these instructions are important for your own personal safety.
- Always observe the applicable regulations of the Labour Inspectorate to avoid accidents.
- Read and observe all safety messages indicated on the machine in the form of stickers or icons.
- Under no conditions whatsoever may the original design of the machine be modified without written consent of ELIET EUROPE NV (Belgium).

7.3.2 Careful and cautious use

- This machine is designed solely for chipping branches, prunings, leaves and all kinds of organic garden debris and shall be used for this purpose only.
- As chipping involves ongoing considerable physical effort, take regular breaks for food intake, rest and drinking.
- People with heart problems and/or balance disturbances are advised against operating this machine.
- Think about what you are doing at every manoeuvre. Do not be tempted to let routine dull your attention. Never act impulsively or on reflex.
- Although the machine is equipped with extensive safety features, please avoid dangerous situations.
- Never work with a machine that has not been fully assembled. Check the finish of the machine to ensure compliance with the instructions provided in this manual.
- Never operate the machine without the feed hopper fitted.
- Never use the chipper when the base, the handle or the blow chute is not properly mounted.
- Never use a step when feeding garden waste into the machine.
- For this model, ELIET prescribes a maximum branch diameter of 45 mm. For your own safety it is prohibited to exceed the prescribed diameter.
- Do not constantly feed the maximum branch diameter of 45 mm. As a guideline, no more than

10% of the material to be processed should exceed a diameter of 40 mm.

- Never attempt to shred frozen branches.
- Never feed burning objects into the machine (e.g. burning cigarettes, charcoal, etc.).
- Never insert your hands beyond the safety shield while the machine is in operation.
- Avoid feeding foreign objects into machine. (ropes, stones, metal, plastic, textiles)
- For ethical reasons, Eliet distances itself completely from any shredding activities with its machines involving animals or living organisms.
- Never use metal tools to push garden waste into the feeding hopper.
- Never use your feet for pushing green waste down the feeding hopper.
- Never place any tools into the feeding hopper.
- Never work when light intensity is below 500 Lux.
- Always work on a stable and flat surface.
- Never use the machine when it is on a gradient.
- Never attempt to change a machine setting and never perform maintenance when the motor is running.
- The machine may cause an explosion when you work near flammable products, fumes, etc.

7.3.3 Operator's responsibilities

- All persons using the machine are assumed to be fully conversant with the safety instructions. They are fully liable for the use of the machine in regard to themselves **and third parties**.
- The operator of this machine is assumed mature enough and with enough common sense to make decisions by himself.
- The machine may not be operated by minors. However, this does not apply to youths over the age of 16 who are learning to operate the machine under the supervision of an experienced operator.
- A disabled person may only operate the machine under the supervision of an experienced operator.
- Children (under 16 years of age) and animals should be kept at a safe distance (3 m) from the machine.
- ELIET advises against lending the machine to others. However, if this should occur, it should only be lent to persons who are familiar with it. **Always make sure that the user is aware of the potential hazards and ensure that he/she reads the manual before using the machine.**
- This machine must only be operated by persons who are well rested and in a good physical condition. Take a rest if you become tired whilst operating the machine. The machine should not be operated after the consumption of alcohol or use of drugs.
- The user must draw up a list that registers the number of hours worked. This will ensure that the proper repetitive machine maintenance schedule is followed.

7.3.4 Personal protective equipment (PPE)

- You must wear suitable clothing to operate this machine. This implies clothes covering the entire body and heavy protective gloves and closed non-slip footwear.
- Do not wear loose-fitting clothing (a shawl, for instance, should be avoided at all times). Long hair must be contained with a cap or a headband, or worn in a ponytail.
- For protection of the most sensitive senses, Eliet recommends ear protection and safety goggles.
- You must pay extra attention and be more careful when wearing ear protection because noises that announce a danger (such as shouting, signal sounds) will only be heard to a limited degree.
- ELIET strongly discourages using a Walkman or a portable MP3 player while working.
- Chipping may result in dust production. Should your lungs become irritated as a result, we recommend that you wear a dust mask in accordance with directive: 89/686/EC.

7.3.5 Danger zone

- Never allow bystanders within the danger zone - a circle of 10 m around the machine - while working.

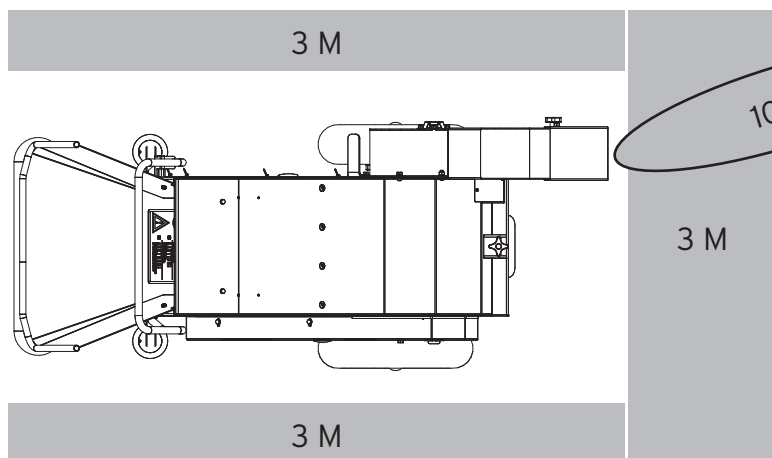

- The best position for feeding green waste into the hopper is at the back of the machine. Do not bend over the feed hopper; in this way you will remain outside the projection field of wood chips that could fly out through the anti-projection flaps.
- Do not enter the discharge zone when the machine is in operation.
- Contact with moving parts may cause injury or damage. Make sure that your hands, feet or any loose clothing are well away from moving parts.
- Only operate the machine when it is in a normal working condition.
- Never tilt the machine during operation in order to reduce the standard feeding height.
- Do not take any risks and immediately stop the machine as soon as anyone enters the danger zone.
- Children and animals must be kept well away from the machine.

- Shut off the engine when leaving the machine unattended.
- Once the engine is running, the operator will focus all his attention on operating the machine.

7.3.6 Periodic maintenance

- Periodic maintenance is essential. You must therefore strictly follow the maintenance schedule provided in this operating manual.
- Draw up a maintenance register in which you keep the performed maintenance updated in detail.
- Checking the blades for sharpness is essential for proper operation of your machine. Sharpen the blades as needed.
- Check the blade bolts for tightness within a run-in period of 5 hours after having installed new blades or reversed used blades. This also applies to the first 5 hours after putting the machine into operation.
- Always request genuine ELIET replacement parts from your ELIET dealer if parts require replacement due to wear or failure. This is important for your own safety (find an official ELIET dealer near you at www.elieta.eu)
- For a list of original replacement parts and their ordering codes please visit www.elieta.eu.
- Always make sure the engine is switched off before performing repairs or maintenance. Always wait until the blades have come to a complete standstill and ensure that the shredding chamber and turbine are completely empty before performing any action whatsoever.
- Always wear suitable clothing for performing maintenance.

Use the machine in a manner that respects environmental regulations:

- Avoid running the machine when not actively using it.
- Avoid spilling petrol while refuelling.
- Service the engine regularly for optimum combustion.

7.3.7 Guidelines related to the electric machines

On machines powered by an electric motor, the following guidelines must also be observed.

- The power circuit to which the machine is connected must be protected by a Residual Current Device which switches off at a maximum of 30mA.
- The mains of the residence to which the machine is connected should be equipped with proper grounding; have this checked by a certified electrician.
- The power switch on the machine has an integrated thermal protection. If the internal motor temperature exceeds a standard value due to long-term heavy loading, overloading, blockage or faulty cooling, the engine will automatically switch off. Allow the motor to cool down and restart it according to the described starting procedure
- We recommend using an extension cord in accordance with the CE standard that meets protection rating IP65.
- Never use an extension cord that shows signs of damage. This usually means that there is a real risk of a short-circuit or electrocution.

- Ensure that the extension cord is not near hot or sharp objects that may perforate the cord while the machine is operational.
- When the connection is made to a socket that is located outside, this socket must conform to protection rating IP65.
- Ensure that the plug always fits the socket and that the plug pins always disappear inside the socket. Otherwise there is a real danger of electrocution. If the plug does not match the socket, ask an electrician to replace the plug or socket.
- Never remove a plug by pulling on the cord; this runs the risk of a short-circuit.
- It is forbidden to operate the machine during rainy weather. Never expose the machine to water ingress.

**Warning:**

Using an inappropriate extension cord (gauge, length or plug quality) may lead to serious damage to the machine. Such damage will cancel any claims on the warranty.

**Warning:**

Electrocution can occur should you connect a plug to the electric mains while your hands are wet.

**Warning:**

Electrical equipment may cause short circuits when exposed to water and moisture. Therefore, always ensure electrical components are dry.

8. Dealer's duties

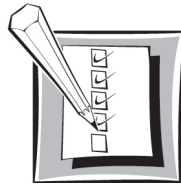

Warning:



As an ELIET dealer you **must** familiarize your customers with the **operation of the machine** and also **point out the possible dangers** while using it. You are expected to carefully go over the maintenance points of the machine together with the new owner. Repeat these instructions until the new owner has fully understood everything.



Warning:

As manufacturer, ELIET once again emphasizes that the dealer must emphatically point out **that all of the blade bolts must be tightened** within the first 5 hours of operation.

FOR SAFETY REASONS ALL THE BLADE BOLTS MUST BE RE-TIGHTENED AFTER THE FIRST 5 OPERATING HOURS. (TORQUE: 25 Nm.)

Failure to do this may cause serious injury and even lead to death. In addition to damaging the machine, it also voids the warranty. See the list with tightening torques in the appendix.

- ELIET machines are packaged in accordance with common rules for proper transportation. Deliveries are always ex factory. Consequently, ELIET cannot be held liable for any damage that occurs during transport.
- If the packaging is damaged upon receipt of the goods, check the state of the machine to ensure it is not damaged. Report any irregularities on the delivery order before signing for receipt.
- In case of damage to the machine, a complaint to the shipping company must be submitted immediately after delivery.

When first removed from its packaging, the machine is not yet fully assembled. It is the task of the dealer to finish the assembly. Below we provide a few guidelines:

- The first part to be mounted is the handlebar. It is locked into position in the provided holes using two M6 bolts (use a size 10 spanner).

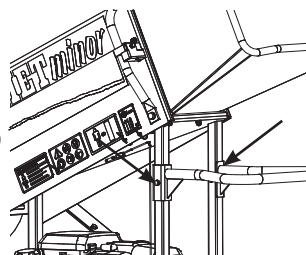

- Then, the hopper at the front of the feed opening must be installed using the M6 bolts, pinions and nuts

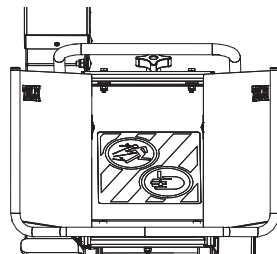

- Next, the wheel axis is slid onto the chassis and fixed with two pinions, after which the wheels can be slid onto the wheel axes. Before doing so, a little grease (Sunoco Multi-purpose LR-EP2) may be applied to the roller bearings. Finally, the wheels are tightened to the axes using the supplied Starlock caps.

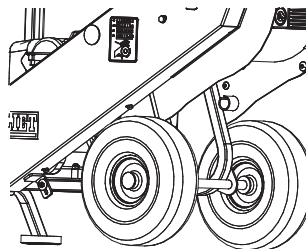

- The machine's blow chute is pointed to the front of the machine. This must first be turned before the machine may be operated. The way in which this blow chute must be turned is described in appendix B1.

- The dealer will set the belt tension according to the details in the maintenance section of the instruction booklet (§ 11.5.5 Belt tension adjustment) Every Eliet dealer is co-responsible for a long life span of Eliet machines. He shall lubricate all hinges before delivering the machine to the client.
- Machines do not contain any oil or fuel when they are packed. The dealer will fill the oil and petrol tanks according to the instructions in this manual (or that of the engine manual).
- The rpm will be set at 3,200 rpm.
- The dealer will perform a test run on the machine and confirm that everything is functioning properly (e.g. safety switches, emergency stop...).
- Finally, the dealer ensures that the user immediately registers the machine online in order to make sure that his right to the warranty is activated.

9. Operating instructions

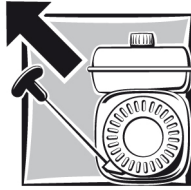

9.1 Preliminary checks



Caution:

Try making a habit of checking the following points before getting to work with the machine:

Checklist

1. Check that the chipping blades are firmly in place and in good condition. For safety's sake, tighten the blade bolts. If the blades need sharpening, this should be done first. Check the blades and the blade holder for cracks and nicks and replace immediately as needed (see § 11.5.6, Reversing and replacing the shredder blades).
2. Check the oil level. Pull out the dipstick and check that the oil level is not below the minimum mark (if necessary, read § 11.4.2 Checking the oil level of the engine).
3. Check that the fuel tank is full. If it is not, add fuel (see § 9.2 Refuelling).
4. Check that the air filter is not heavily soiled (if necessary, read § 11.4.3 Cleaning the air filter).
5. Check that the cover plate at the back of the machine is attached correctly.
6. Check that the belt tension is correct (if necessary, read §11.4.5 Checking belt tension). If it is not, it must be adjusted (if necessary, read §11.5.5. Belt tension adjustment).
7. Prior to starting to work, the operator must check that all the protective covers are in place and correctly fixed.
8. Prior to starting to work, the operator shall verify that the shredding chamber and the turbine are free of any chips.
9. Check that all safety provisions on the machine still function (see § 7.2 Safety features).

Once these items have been checked and approved, you can prepare the area of operation (see § 9.3 Preparing the work site) and move the machine to the work site.

9.2 Refuelling

When petrol in the machine is running low, fuel must be added. The use of fresh petrol is recommended at all times. Use unleaded petrol, preferably with an octane index of 98 or 99.

**Warning:**

Under certain conditions, petrol is extremely flammable and highly explosive. Fires and petrol explosions can inflict severe burns and cause damage to personal property. As a result, please observe the following points:

- Never refuel with the engine running. Always allow the engine to cool off for several minutes prior to refuelling.
- Use fresh petrol only. ELIET is environmentally conscious and therefore recommends the use of unleaded petrol. Additives may be used for extended fuel freshness.
- Store petrol in an approved tank. Keep it out of reach of children.
- Never refuel at the location where the machine will be operated. Keep a distance of at least 10 m from the selected work area. Doing so will avoid creating a fire hazard.
- Clean the area around the fuel cap and remove it. Do not fill the tank completely. Fill up to approximately 10 mm from the brim. Never fill it up to the brim.
- Always use a funnel or a spout for refuelling. Special funnels are available from your ELIET dealer.
- Put the cap back on the fuel tank as quickly as possible. If any petrol is spilled during refilling, the engine should be cleaned immediately.
- Also ensure that clothing does not come in contact with the petrol. If this happens, it must be changed immediately.
- It is irresponsible and therefore strictly prohibited to refill the tank in immediate proximity to people who are smoking or near open fire.
- If fuel is swallowed or comes in contact with the eyes, consult a doctor immediately.

9.3 Preparing the work site

- Clean up the area where the machine will be operated prior to starting the work.
- The routes used to bring in the cutting materials must be freed of any obstructions to avoid tripping hazards. Here, too, operators must secure their safety.
- Never operate the machine on - forward, backward or lateral - slopes.
- The material to be chipped is to be sorted beforehand. This helps to avoid feeding foreign objects into the machine.
- Foreign objects include: anything non-organic or which exceed the prescribed maximum diameters (e.g. metal, stone, synthetic materials, ropes, textiles, etc.). Some of these items can cause serious damage to the machine or could be ejected as projectiles towards the user.

9.4 Starting the engine



Caution:

Never start the machine when dust has settled on the engine or in between its cooling fins. It reduces proper cooling of the engine and can cause a fire.



Warning:

The blade shaft is driven directly by the motor. The blades are never disconnected. Therefore, the machine becomes dangerous as soon as the engine starts running. In any situation that could lead to loss of control over the operation, the engine must be switched off immediately. How to quickly switch off the machine:

1. pressing the emergency stop bracket backwards will stop the engine;
2. the engine can also be switched off with the stop switch or the rotary knob

- Any chips still in the shredding chamber must be removed before starting the machine. Failure to do so may damage the starting mechanism. If starting the engine is impossible nonetheless, a check should reveal whether any stuck wood chips are obstructing the turbine.
- Ensure that the feed hopper is empty (no garden waste, no tools, etc).
- Please note that the engine will not start unless the emergency stop bracket and the cover plate are in the correct position.
- The machine becomes a source of danger as soon as the engine is running. The cutting mechanism may eject wood chips at any moment. The machine therefore must be positioned with care, ensuring that the deflector cap is pointing in the direction where any flying objects can

do no harm.



Warning:

For optimum protection of your hearing, please put on the supplied ear protection prior to starting the engine.

Unless already done during the preliminary check, the engine must be checked for adequate oil and fuel levels prior to starting it.

For details about how to check and refill the oil, see § 11.4.2 - Checking the oil level

For refuelling see § 9.2 - Refuelling.

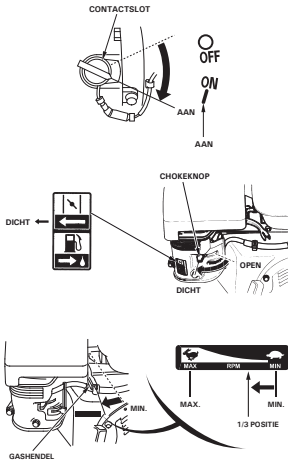

- If the fuel tank is equipped with a fuel tap, open it.
- Depending on the type of engine, put the handle or turn the switch into the ON position.
- Set the choke handle to “Close”.

- Open full throttle, represented by the image of a hare.

- Slightly pull the starter handle until you feel some resistance; then give a brisk pull. Allow the starter chord to recoil back.
- Once the engine is running, set the choke handle to “Open”. This prevents the engine from getting too much fuel. Failure to reopen the choke will cause the engine to slow down and it will start producing a lot of smoke. Eventually it will come to a full stop. Restart the engine without opening the choke if this happens.
- The engine refusing to restart could point at a greased spark plug. If that is indeed the case, clean or replace the spark plug (see 11.5.2 Checking/replacing spark plug).



For your information:

The procedure to start the engine may vary per brand. Read the engine manual about this in Chapter 'General' in §6. The main machine parts are shown in various versions.

9.5 Stopping the engine

PUSHING THE EMERGENCY STOP BRACKET BACKWARDS = ENGINE OFF

- To stop the engine, switch the throttle or turn the knob into the "OFF" position.
- The machine can also be stopped by pushing the emergency stop bracket backwards.
- If the machine is equipped with a fuel tap, close it.

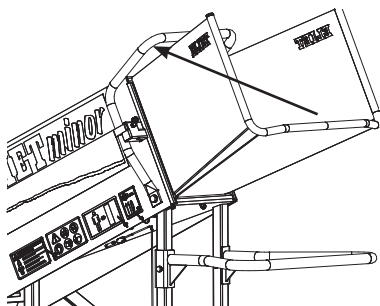

Caution:

As long as the engine has come to a full stop after turning it off, the blades will continue to turn. Do not perform any maintenance work before they have come to a halt.

9.6 Operating the machine



Warning:

Protective covers provide protection against rotating parts. It is therefore prohibited to reach behind these covers with any body parts while the engine is running.

9.6.1 Before starting the work

Pay attention to the following safety instructions before operating the machine.

- The operator must wear suitable clothing, gloves and other protective attributes as prescribed in this manual (see § 7.3, Safety instructions).
- A good gardener works efficiently and according to a well defined plan. It allows him to keep an overview of his work and prevents accidents or wrong manoeuvres with the machine.
- The wood should be stacked systematically before commencing the work; thick branches, thin branches, leaves and damp products. Ensure that the material does not contain any foreign objects.
- The deflector cap must be pointed in the right direction before operating the machine. Make sure that you will not have to pass through the projection zone of the blow chute while transporting green waste.
- The engine should not be started before having arrived at the work site.
- Ensure the power supply cable is routed so that it does not hinder the feeding of wood to be chipped. This could cause the operator to stumble.
- Never run a petrol engine in a closed environment - doing so involves a risk of carbon monoxide poisoning from the exhaust.

9.6.2 While working



Caution:

While feeding green waste into the machine, the operator should never reach behind the steel shield. By lifting the plate, the operator removes the protection against flying wood chips.



- When inserting the material, always hold it firmly. The rotational direction of the blade shaft and the teeth on the blades make for steady material feed into the hopper. If the wood is not firmly held, it will be pulled into the chipper too rapidly; this will inevitably lead to a blade shaft jam. In other words, the operator controls the speed at which the wood is fed into the hopper (fast or slowly). The speed will depend on the thickness of the branch.
- Listen to the engine attentively when feeding in the wood. Should you notice a significant drop in rpm, immediately pull back the wood to allow the engine to speed up again.

- It is useless to feed too much material into the machine at once. Reducing the material volume speeds up the entire process.
- When inserting branches, the thickest end of the branch will have to be introduced into the feed hopper first.
- Preferably feed the branches into the right side of the hopper. That way the chips sit in the shredding chamber for a longer period before being sucked towards the turbine. This also ensures that the chips are smaller in size.
- In the event that the volume of leaves to be processed is very large, ELIET recommends to alternately shred leaves and branches.
- Cease operation immediately when you hear unfamiliar sounds. Stop the engine (emergency stop bracket) and examine the cause of the sound. Perform any necessary repairs before continuing.
- Should you notice that, despite all of the preparations made, a foreign object still has found its way into the machine, the motor must be shut off immediately. Remove the foreign object and check for damage. Any defects must be repaired before resuming operation.
- The engine should, in principle, shut down automatically when the shredding chamber is opened. If it does not as a result of an electrical defect, the operator immediately must turn off the engine manually and refrain from using the machine until it has been repaired.
- If the shredding chamber gets clogged up, switch off the machine to remove the blockage. Make sure to wait for the blades to come to a complete standstill before carrying out any operation on the machine.

9.6.3 After the engine stalls

Overloading, overfeeding, blockage of the discharge, fuel shortage, a closed fuel tap, insufficient oil, the safety handle in the wrong position and improper closure of the shredding chamber are all possible causes of a stalling engine. The chipper can be easily restarted in these cases. Proceed as follows:

1. Check the petrol level in the tank (see § 9.2 Refuelling).
2. Remove all branches from the feed intake opening.
3. Briefly pull the starter cord to verify whether the blade axis is still blocked. As soon as you feel resistance and are unable to pull the cord any further, simply release the cord. It is useless to pull the cord forcibly as this could cause it to break or overload the starter mechanism.
4. If the blade axis is blocked, the shredder compartment must be emptied. This requires opening of the shredding chamber. The cover screen is attached at its top with a star screw. Remove the star screw and lower the cover.

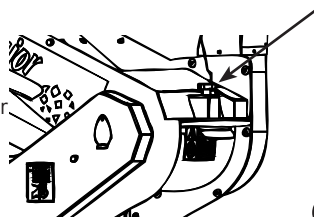



Caution:

Always wear gloves when performing maintenance. You will be near the blades when emptying the chipping chamber. The blades are razor-sharp and therefore represent a real risk of cuts. Take care and try to avoid all contact.

5. Remove all the chips and wood residue from the shredding chamber. Reinstall the cover plate and check that it is done properly.
6. In the event that a wood chip is blocking the impeller in the turbine, the turbine must be cleared. For the exact procedure, see Appendix B1 - Clearing the turbine.
7. In the event of blockage of the blow chute, the chute must be disassembled to be able to clear it. See Appendix B2 - Disassembling the blow chute.
8. Perform the work more carefully in the future in order to avoid jamming of the machine.

10. Transporting the machine

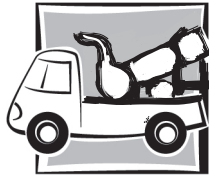

- Only adults are permitted to move or transport the machine.
- The shredding chamber and the turbine chamber must be empty before transporting the machine. The feed opening should not contain any branches.
- During transport, children, unauthorised people or animals must not be allowed within a 3 m radius of the machine.
- Prior to moving the machine, no matter at what distance, one must always wait until the shredding chamber is empty. The feed opening should not contain any branches.
- The engine must be off before transporting the machine.
- If the machine topples over for some reason, set it upright as quickly as possible. This prevents oil from the crankcase entering the air filter.
- Use non-slip planks for loading the machine into a van or onto a trailer. Ensure that the planks are properly fastened to the vehicle or trailer.
- Under no circumstances should the upwards slope exceed 25°.
- Never drive or place the machine on a surface that cannot support the weight of the machine and the operator (for your information: assume a net weight of 92 kg for the machine).
- When ascending a slope, the blade axis must be placed at the front.
- When descending a slope, the blade axis must be placed at the back.



- Never use the machine for transporting objects or people.
- Carefully choose a clear and free transport path, preferably one with as few obstructions as possible.
- The transport route is preferably flat, with an even surface.
- Ensure that there is a sufficiently large run-out zone behind the ramps (4 m).
- Ensure that the parking brake of the vehicle is on.
- Be careful and composed when loading and unloading the chipper so that the machine does not tip over and can cause an accident.
- The maximum allowable lateral slope angle is 10°.
- Make sure to properly secure the machine to the vehicle during transportation.
- Never tilt the machine more than 12° when transporting the chipper; the machine might flip

over backwards otherwise.

- Ensure that the vehicle/trailer is not overloaded. The chipper has a net weight of approximately 92 kg.

11. Maintenance



11.1 General

ELIET recommends that the machine be brought to an official ELIET dealer for a major overhaul each year (find an authorised ELIET dealer near you at www.elieta.eu). Your ELIET dealer is at your service for maintenance and advice at all times. He stocks genuine ELIET replacement parts and lubricants. His staff can always obtain advice and service from ELIET's help desk in order to provide you with an impeccable after-sales service.



Caution:

Use only genuine ELIET spare parts when performing repairs. These service parts are manufactured according to the same strict quality requirements and craftsmanship as the original equipment. You can always consult the list of original replacement parts and their ordering codes at www.elieta.eu.

Perform maintenance in a room intended for this purpose. The area must meet the following criteria:

- Spacious
- Dust-free
- Easily accessible
- Clean and tidy
- Well lit
- Quiet

These characteristics are important to properly carry out maintenance tasks.



Warning:

Maintenance performed in an incorrect manner may compromise the operator's safety. Damage or consequential damages that arise from insufficient or faulty maintenance will void the warranty. Thus, maintenance must always be performed by experienced technicians.

**Caution:**

Maintenance must always be carried out with the engine turned off.

**Caution:**

Always wear safety gloves when performing maintenance. Additionally, safety goggles may be required for certain operations. These are supplied with the machine.

11.2 Maintenance schedules

11.2.1 Lubricants

Engine (0.75 l.)	SUNOCO SUPER DENALUBE SAE 20 W 50 API SF / CC
Hinges	NOVATIO WHITE SUPREME GREASE
Wheel axles	SUNOCO MULTI-PURPOSE GREASE LR - EP2

11.2.2 Special maintenance

A. Special maintenance of the blades

Once mounted on the blade shaft, the blades will settle into position after a short break-in period. This can cause the tension on the bolts to decrease, with the risk of the blades becoming dislodged in between the blade plates. This can cause irrevocable fatigue failure of the blade shaft and must be prevented by scheduling extra maintenance after a brief running-in period.

WHEN:

Within the first five operating hours after commissioning the new machine.

Within the first 5 hours after reversing the blades.

Within the first 5 hours after replacing the blades.

WHAT: Check the torque of the bolt connections securing the blades and tighten them as required (torque: 25 Nm).

**Caution:**

Use a calibrated torque wrench.

**Warning:**

Failure to perform this special maintenance could result in the blades coming loose while working. This will cause serious damage to your machine and also represents a major risk of serious injury or death to the user or bystanders. All damage or subsequent damage caused as a result of this negligence falls outside the guarantee.

11.2.3 Periodic maintenance schedule

A. Routine check before each operation

- Visual check of the state of the machine (see 11.4.1 Visual check)
- Checking the engine's oil level (see 11.4.2 Oil level check).
- Cleaning the air filter (see 11.4.3 - Cleaning the air filter)
- Check the machine for signs of abnormal wear or fractures.
- Check that the bolts are securely tightened (blades, wheels, bearings, engine, etc.).
- Sharpening the blades. (See 11.4.4 - Sharpening the blades.)
- Belt tension check (See 11.4.5 - Checking the belt tension)
- Cleaning the machine. (See 11.3 - Cleaning the machine.)

B. Maintenance after every 20 hours of operation

- Daily maintenance (see § 11.2.3.A).
- Changing the engine oil
- Checking and/or changing the spark plug
- Changing the air filter
- General lubrication treatment
- Belt tension adjustment
- Reversing and/or replacing the blades.

11.3 Cleaning the machine

11.3.1 The importance of cleaning

ELIET recommends cleaning the machine after each use. We recommend performing an inspection each time you clean the machine to check component and machine integrity. This allows timely intervention and prevention of any defects, ensuring a longer service life of your machine.

Failure to regularly clean the machine will lead to:

- Increased wear.
- Increased risk of fire.
- Reduced engine cooling.
- Increased risk of short circuits.
- Reduced performance.
- Illegibility of safety stickers.
- Not noticing defects or wear at an early stage.
- Fire risk

REMARK: Failure to perform the daily clean-up will result in loss of warranty.



Warning:

Any suboptimal performance of the machine can compromise the operator's safety.



Warning:

Wood residue, chippings and fine dust can accumulate under the covers and cause a fire as a result of overheating. Avoid dirt accumulating near electric components or the engine. Clean the machine thoroughly on a daily basis.



Caution:

Wear suitable clothing for cleaning activities. Utility gloves are essential.

11.3.2 What does cleaning entail?

Cleaning the machine implies a thorough check-up and inspection of the machine. Check that no parts have been deformed, that welded seams are not cracked and that parts are not excessively loose.

Important points include:

- Blade shaft welding seams.
 - Bolts for blade attachment.
 - Blade shaft retaining bolt.
 - Turbine welding seams.
 - Anti-projection flaps in feed hopper.
-
- The engine should be clear of dust and dirt. The cooling fins in particular as well as the area around the exhaust must be clean. The area around the fuel cap must be kept clean to avoid dirt entering the fuel tank.
 - The bushings must be cleaned of sand and dirt that has become stuck in the lubricating grease. Reapply lubricating grease after wiping the bushings.

Any necessary replacement and/or repair works must be undertaken immediately. Ask your authorised ELIET dealer to carry out repairs (find an authorised ELIET dealer near you www.eliyet.eu).

Cleaning the machine involves more than just cleaning the outside. Open all protective covers so that you can also clean the inside of your machine.

The following points require special attention:

- Dirt (chippings, wood residue, dust, sand, sticky leaves, etc.) accumulated inside the machine must be removed. Use a soft brush or vacuum cleaner to remove this dirt.
- Fibre strands that have wrapped themselves around the blade shaft should be removed to prevent them from damaging the bearing seals of the engine.
- Remove all accumulated sticky dirt inside the chipping chamber.
- Remove all accumulated sticky dirt inside the turbine and the blow chute.



Caution:

Always wear gloves when performing maintenance. You will be near the blades when cleaning the chipping chamber and the turbine. The blades are razor-sharp and therefore represent a real risk of cuts. Take care and try to avoid all contact.



- Using a dry cloth, remove any dirt from the frame, Pay special attention to places where stickers with safety messages are displayed (do not use any cleaning products that affect paint or stickers).
- Any stickers that are no longer legible must be replaced. Original stickers can be purchased from your ELIET dealer.
- Compressed air can be used to easily blow out and clean some parts.
- A steamer may be used for cleaning the machine. provided that the stream of water is not be overly pointed at bearings, protection covers and filler caps. Water is the number one cause of rust and this must be avoided at all times. Allow the engine to cool down properly before treating it with water.
- A vacuum cleaner is an efficient tool for removing dirt even if it is located in hard-to-reach locations.



Warning:

Should removing the protective cover be required for performing maintenance, make sure to replace it correctly when you are done. Safeguards are there to protect you.

11.4 Routine check prior to any operation

11.4.1 Visual check

Check that no parts have been deformed, that welded seams are not cracked and that parts are not excessively loose. If problems are found, carry out the necessary repairs first. Check that the machine is running at the correct rpm (3,200 rpm). (An rpm counter can be obtained from your ELIET dealer.) Never attempt to change the default settings of the engine.

11.4.2 Oil level check.

Refer to the part 'Engines' under § 6 - 'Main Machine Parts' for possible positions of the oil dipstick and the oil drainage and drain plugs.

- Take a clean cloth.
- Pull the dipstick from the filler opening.
- The oil level will usually be hard to read immediately. Clean the dipstick and put it back into the filler opening. Do not tighten it.
- After pulling it out again you will get an accurate reading of the oil level.
- The oil sticking to the dipstick should be between the minimum and maximum mark.

If the oil level is too low, it can be filled via the oil filler. Use recommended oil only. Do not add too much oil at once and check the oil level regularly.

11.4.3 Cleaning the air filter

- The type of air filter depends on the engine brand and type.
- The air filter is located under the black protection cover next to the fuel reservoir on the engine.
- Loosen the black protection cover.
- There are two types of filter. Besides the common sponge filter there is a filter that, as in an automobile, consists of paper layers.
- Sponge filters can be cleaned by rinsing them with some petrol and blowing them with compressed air.
- Paper filters are cleaned by dusting them down or cleaning with compressed air.
- After cleaning, return all parts to their original positions.



Caution:

In the event the machine has toppled over for some reason, check the air filter immediately. The unusual position of the engine may have caused oil to seep from the crankcase via the carburettor onto the air filter. Oil on the filter paper obstructs the air passage. Soiled filters must be replaced immediately.

11.4.4 Sharpening the blades

Sharp chipping blades will provide optimum performance and maximum operating speed. Enhance your own work comfort by taking some time to check the blades, and if necessary, sharpen them.

SHARP BLADES = MAXIMUM OUTPUT



For your information:

The blades need not be disassembled for sharpening. Use a small right-angle grinder equipped with a grinding disc that is suitable for steel.



Warning:

Always wear safety glasses and ear protection when sharpening blades. Gloves are also required when performing maintenance.

**Warning:**

When tilting, petrol can leak out from the filler cap of the reservoir. Pump any surplus petrol from the reservoir using a siphon, as a spark from sharpening the blade can cause fire.

- Tilt the machine forward until it leans on its front base and the handlebar (see illustration).
- Disassemble the cover plate at the back of the machine by removing the star screw and unhooking the cover from the machine.

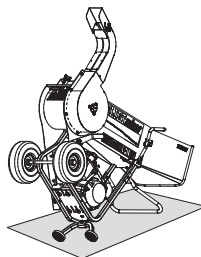

- When sharpening, the grindstone of the right-angle grinder should be pulled along the bevelled side. Ensure that the cut retains its original angle. The top of the blade suffers most during chipping. Grind it as little as possible to avoid weakening. Correct and timely sharpening of the chipping blades will extend blade life.

**For your information:**

As soon as the top of the cutting edge becomes the blades are used up and have to be replaced or reversed.

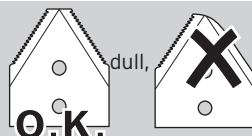
**A blade has two sides.**

- The front of the blade has the two bevelled cutting edges. **(F)**
- At the back, the tooth profiling of the cutting area is clearly visible. **(R)**

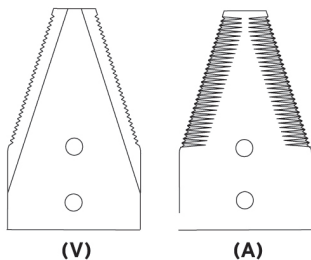

A sharp cutting edge and correct cutting angle are essential for efficient chipping. Blades must be correctly sharpened to ensure these two features can be realised.

- If blades become dull, the sharp cutting edge will become worn and will be upset to form a wider rib. **(1)**
- By grinding a little metal from the cutting edge, you can again obtain a sharp cutting edge from this wide rib. **(2)**
- Sharpening is performed by moving the grinding disc along the angled cutting edge.
- Remark: By regularly grinding, you will only have to grind away a thin layer of the metal each time to again obtain a sharp cutting edge. This will ensure very short grinding times and you will always have the best possible cutting edge.
- Avoid grinding at the same location for a long period of time. In this way you avoid local discolouration of the blades indicates heating, resulting in a change of the material structure and decreased hardness.
- It is extremely important to respect the existing cutting angle when grinding. **(3: blade sharpened wrongly)**
- When the correct cutting angle is not observed, due to grinding a blunt angle **(4)** or an interrupted cutting angle **(5)**, the blades will be slowed by the wood, resulting in a loss of capacity. Too sharp a cutting angle **(6, 7)** will lead to a weakened cutting edge and consequently, to a considerably shorter blade life.

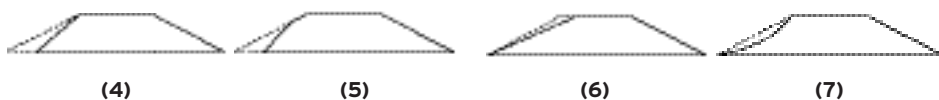
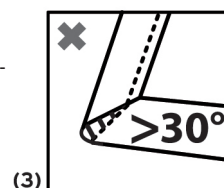
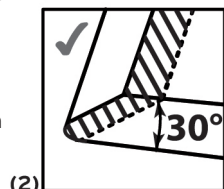
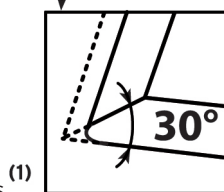
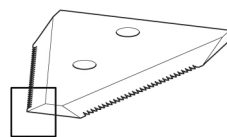

- Never grind the rear side of a blade. On RESIST/6™ blades, the profiling is on the rear. If you grind away the teeth, the blade will lose a great deal of its cutting force.
- The top of the blade suffers the most during chipping. Therefore it is best to grind them as little as possible to avoid weakening.
- At each grinding service, the active cutting edge becomes a little bit smaller due to the removal of a small bit of the material. Blades may be ground until half-way through the width of the blade tip. Exceeding this limit compromises the service life of the unused cutting edge. We recommend reversing the blades at this point (see § 11.4.3 Reversing and replacing chipper blades).
- Rounded-off blades offer reduced chipping efficiency. In this event, further grinding of the blade serves no purpose. This is the time to reverse or replace the blades.

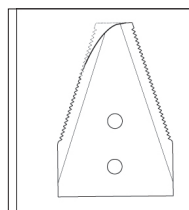
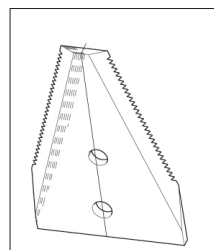

11.4.5 Checking the belt tension

**Warning:**

Only check the belt tension with the engine off. Remove the spark plug cap.

- The protective cover over the drive contains a black, round cap. Pull it away from the hole.
- Through the opening you can clearly see the V-belt. When pressing the belt down with one's thumb (applied force approximately 7.5 kg), it should not move more than 1 cm. In that case, the tension is sufficient.
- Put the rubber cap back in place after checking the belt tension.
- If the belt tension proves to be too loose or too tight, it must be adjusted. A loose drive belt will bang against the protective cover.
- Because a new belt will expand somewhat during the first period of operation, it is recommended to adjust the tension after 10 hours of operation (see § 11.5.5 Adjusting belt tension).

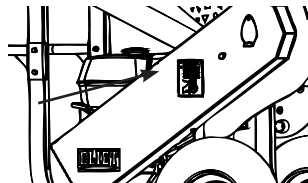

11.5 Maintenance after 20 hours of operation

11.5.1 Changing the oil

- Ensure that the engine is on an even surface and turned off.
- At the rear of the engine, below the engine base, a plug is screwed into the crankcase (see the engine manual).
- Get a one litre collection reservoir before unscrewing the plug.
- Empty the full contents (approx. 0.75 l) from the engine.
- Replace the plug on the drain. Wipe away any spilled oil with a clean cloth.
- Refill the engine with fresh 4 stroke oil. For this, ELIET recommends using high-quality oil with a high detergent level: SUNOCO DENALUBE SAE 20W50 API SF / CC.
- Fill approx. 0.75 litres of oil into the oil filler opening. Remove any spilled oil after filling. For an accurate dipstick reading of the oil level, allow sufficient time for the oil to settle in the crankcase.
- Place the dipstick in the filler opening without fastening it. After pulling it out again, the oil attached to the dipstick should reach the maximum mark. If not, more oil must be added.



Warning:

Oil shortage causes severe engine damage.

11.5.2 Checking and/or changing the spark plug

ELIET suggests the following spark plugs:

6 hp Honda GC190 - GX200	Champion QC 12 YC
6.5 hp Vanguard	NGK BPR 6 ES

- Turn off the engine and pull the cable from the spark plug.
- Clean the area around the fuel cap and remove the spark plug from the cylinder head.
- Using a feeler gauge, check whether the distance between the electrodes is 0.8 mm.
- If spark plug shows heavy deposits or is very dirty, it has to be replaced.
- Take the following steps to verify ignition quality:

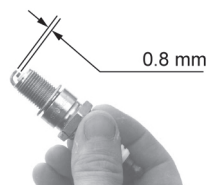

1. Put the spark plug cap back on.
2. Grab the rubber of the spark plug cap and press the outermost electrode against the mass of the engine.
3. Pull the starter cord.
4. Check for sparks between the electrodes.
5. The spark plug is in good condition if the sparks are clear and neatly centred between the electrodes.
6. Weak, irregular and off-centre sparks between the electrodes indicate that the spark plug must be changed.

**Caution:**

Fitting or changing a spark plug must be done with utmost caution so as not to damage the screw thread in the engine. Secure the spark plug with a torque of 20 Nm.

11.5.3 Changing the air filter

- This procedure is exactly the same as for cleaning the air filter (see § 11.4.3, Cleaning the air filter).
- New, suitable air filters are available from your ELIET dealer or an authorised service centre of the relevant engine brand.

11.5.4 General lubrication treatment

ELIET is committed to using high-quality materials that extend a machine's life cycle despite the sometimes extreme work circumstances in which chippers are being used. For this reason, special lubrication products have already been applied in the factory. ELIET also recommends lubricating all the parts below on a regular basis:

- Bearings
- Hinges

A. Lubricating bearings

**Caution:**

As applies to all maintenance work, the engine must be turned off. Detach the spark plug cap or lead. Wearing gloves is essential here: the blades are razor-sharp and can cause deep cuts.

- Remove the star screw and lower the cover.
- Spray some MoS₂-based penetrating oil on the blade axle's bearing bush and give it a few minutes to work in.
- Use a duster to remove all dirt that has adhered around the bearing seams. Spray the penetrating oil into the seams of the bearing seals again so that the oil can penetrate the bearings.
- All excess spray should be removed.
- Spray Novatio White Supreme Grease into the seams of the bearing seals.
- The whole blade axle can also be sprayed with penetrating oil. Given that MoS₂-based penetrating oil treats rust, the use of this product can never be harmful.

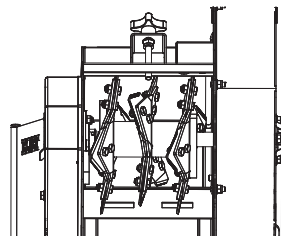

A. Lubricating hinges

'Hinges' mean: the hinge on the safety bracket; the hinge on the base; and the hinge on the deflector valve of the blow chute.

- Start by spraying some penetrating oil into the hinges. Leave it to work for a few minutes.
- Wipe away old lubricant with a cloth or paper tissue. Once the hinges have been cleaned, spray them with Novatio White Supreme Grease.

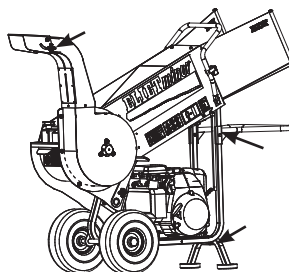

All of the lubricants mentioned are available from your ELIET-dealer; for the dealer nearest you, check www.eliyet.eu.

11.5.5 Adjusting belt tension



Caution:

When adjusting the belt tension the engine must be turned off and the spark plug cap removed.

- In order to adjust the belt tension, the protection cap must be removed. To do so, the 4 M6 bolts (without nut) must be unscrewed. The cap is also fixed to the chassis with an M6 bolt which has a cap nut and an M8 bolt at the front of the cap. Two ring spanners (10 mm and 13 mm) are required for this.

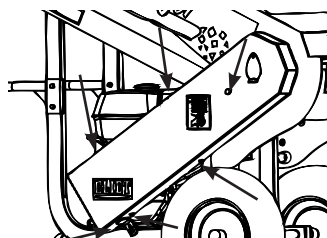

- In order to check the exact belt tension, a weight of 7.5 kg must be hung on the V-belt. If the belt sags 1 cm, the belt tension is correct (see illustration).

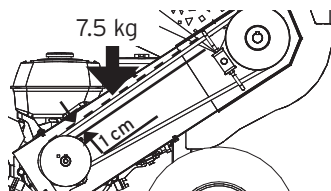

- Adjust the belt by sliding the engine block forward.
To do this, the four M8 bolts on the engine base must be unscrewed (2 x ring spanner 13). Loosen the (M10) bolt at the front of the engine block after having removed the lock nut. Via the nut at the back of the engine, the engine block can now be moved forward.
- Before unscrewing the machine, using a felt-pen two points must be marked on the chassis plate to both sides of the engine block. This will save time afterwards when lining up the pulleys.
- The (M10) bolt at the back is tightened until the correct tension is obtained. The bolt is then fastened with the lock nut.
- The two belt pulleys can now be lined up by screwing back the bolt at the front of the engine. The pulleys are aligned if a slat, held against the pulleys, touches the four indicated points (see illustration).

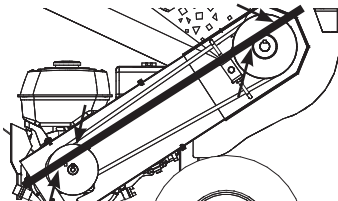

CORRECT TENSION + CORRECT ALIGNMENT => LONG LIFE CYCLE OF THE BELT

- Once the correct tension and alignment have been achieved, the engine can be locked by tightening the bolts (M8) (2 x ring spanner 13).
- Only after everything has been checked carefully can the protective cap be replaced in its original position.

11.5.6 Reversing and changing chipper blades

Regular grinding of the blades provides a blade life of more than 50 hours per cutting edge. After having used up a cutting edge, the blade can be reversed, providing another 50 hours. If both blade edges are worn the entire blade must be replaced.



Caution:

The warranty shall not apply to damage or consequential damage caused by inadequate maintenance of the blades. Consult your official ELIET dealer for advice if required.

11.5.6.1 Work method for reversing the blades



Warning:

Wear protective gloves - the blades are razor sharp!

- Remove the spark plug cable as a precaution.
- As for grinding the blades, the machine is placed on its front foot and the handlebar. Beware of petrol leakage from the reservoir.
- Remove the sealing plate. To do this, loosen the star screw. This will give better access to the shredding chamber.

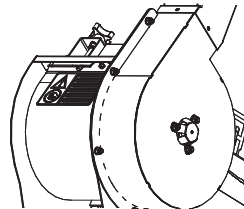

For your information:

Remove and refit one blade at a time. This ensures that reversal is performed in an orderly manner.

- To disassemble the blades, loosen and remove the two (M8) bolts. Replace any damaged bolts. Pull the blades loose with a grip wrench.
- Zone A: for the blades on the outermost blade discs, do the following: Disassemble a blade from the left side; turn it 180° and remount it in the same position on the right hand disc. The blade from the right hand disc is rotated 180° and placed into the vacated hole in the left hand disc. This procedure is repeated until all the blades from zone A have been exchanged.
- One all the blades from zone A have been reversed, check again that the bevelled edges point towards the centre of the shredding chamber, not towards the wall plate. If this is not the case, then two blades were not reversed correctly.
- Zone B: for the blade discs which are enclosed between the discs of Zone A, do the following: Disassemble the blades in Zone B; turn 180° and remount in the same position on the right hand disc. The blade that must be disassembled for this purpose is rotated 180° and placed in the vacated location on the blade axis. This procedure is repeated until all the blades have been reversed (zone B according the illustration). After reversing all the blades from zone B, the bevelled sides should be facing the axis. If not, the procedure was not carried out correctly and must be remedied.

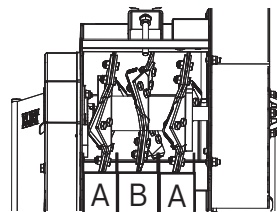

11.5.6.2 Instruction for replacing the blades

A new blade set can be ordered from your ELIET supplier with the following article number: BU 401 200 301.



Warning:

Wear protective gloves - the blades are razor sharp!

- To replace the blades, simply remove the old ones and replace them with new ones. When placing the blades in zone A, make sure that the bevelled side always faces the centre of the shredding chamber. The blades from zone B are slid between the disc plates such that due to the angle of the blade disc, the bevelled side always faces the axis.
- Always fit new bolts and nuts when replacing chipping blades. Your ELIET dealer always has new blades in stock.
- After disassembly of the blades, remove any sticky dirt that has accumulated between the two plate halves before remounting the blades. This can be done with with a stripping knife.
- Tightly fasten the bolts after refitting the chipping blades. It is recommended to check the bolts for correct tightness before refitting the cover plate.
- Always make sure to refit the bolts in the blade holders so that the **nuts are on the "tightening"** side. The direction of rotation of the blade shaft thus automatically protects them from coming loose.
- The next time you start chipping, please bear in mind that new chipping blades take time to stabilise. The bolts may lose some tension, causing blades become loose between the plates.

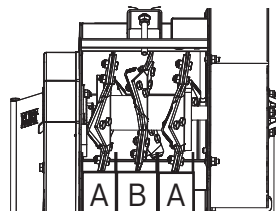

For this reason, you should re-tighten the blade bolts within the first 5 operating hours of the machine (Torque 25 Nm)



Caution:

Incorrectly or poorly installed blades may cause breakdowns or damage to the machine. Operators and bystanders are also put at risk.



Caution:

After replacing the chipping blades, always check the bolts for correct tightness after expiry of the first 5 hour run. Failure to do this may have serious consequences for the operator and for the machine.

12. Storing the machine



Storage preparations

- Clean the machine (see § 11.3 Cleaning the machine).
- Carry out a major overhaul (see § 11.5, Maintenance after 20 operating hours).
- Check all nuts and bolts and fasten them where necessary. Most bolts require the use of two spanners of 13, 13, and 17 mm and wrenches 4, 5 or 6.
- Empty the fuel tank either by running the engine until the machine runs out of fuel, or by using a siphon to pump the petrol back into the jerry can (read the safety instructions under § 9.2 Refuelling).
- Remove the spark plug (see § 11.5.2 Checking and/or replacing the spark plug). Spray some MoS₂-based penetrating oil into the cylinder. Pull the starter cord until the piston is in its uppermost position. Replace the spark plug.
- To avoid rust on the machine, touch up all chipped areas or treat them with anti-rust grease. Original paints/enamels in the appropriate colours are available from your ELIET dealer.
- Allow the engine to cool down before storage.
- If the machine is stored outdoors, it must be properly covered with a tarp. Avoid precipitation coming in direct contact with the machine. ELIET highly recommends a sheltered storage place.
- Store the machine out of the reach of children.
- Never store the machine near heat sources or open flames (at least 2 m distance).

13. Equipment specifications



Choice of engine	380V Driving power
	6.0 hp Honda GC 190
	6.5 hp B&S Vanguard
	6.5 hp Honda GX200
Capacity	45 mm
Yield (wheelbarrows of chips/h)	16
Steel	blade axis diameter 25mm
12 HS steel	blades (reversible)
	3 double steel blade discs
Chipping technology	Eliet chopping principle™
Number of chopping motions/min	30,000
Feed opening	190 x 250mm
Feed height	930 mm
Discharge height	1,100 mm
Wheels (Ø x W / material)	air tires 4.00 x 4
Working dimensions (LxWxH)	1,510 x 490 x 1,160 mm
Transmission	V-belt Gates Guard Power XPA 1600
Chassis	steel plate 2.5 - 3 mm
Sound power Lw(A)	110 dB(A)
Weight	92 kg
Options	Hour counter

14. CE Declaration of Conformity

Machine: **SHREDDER/CHIPPER**
Model: **ELIET MINOR**
Type: **MA 002 011 922**
MA 002 011 216
MA 002 011 118
MA 002 011 206

This machine has been designed and manufactured to comply with the following standard:

“EN 13683: Garden Equipment -Integrally powered shredders/chippers -Safety”

The ELIET machine factory hereby declares that it has performed a hazard analysis and is fully aware of the potential hazards and risks associated with the machine. Based upon this knowledge, the necessary steps have been taken in line with Machine Directive 2006/42/EC in order to ensure full operator safety at correct use of the machine.

The value of the measured sound power and the guaranteed sound power were obtained by applying the procedures described in European Directive 2000/14/EC Annex III/B 50 and regulations from EN 13683.

Measured sound power level: 110 dB (A)
Guaranteed sound power level: 112 dB(A)

Datum: 01/12/12

Signature:

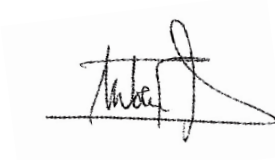

Frederic LIETAER
Business Manager ELIET EUROPE NV
born 02/01/1975

ELIET EUROPE NV
Diesveldstraat 2
B - 8553 Otegem
Belgium
Tel : +32 56 77 70 88
Fax :+32 56 77 52 13
E-mail: info@eliet.be

Appendices:

B1 Turning blow chute

English

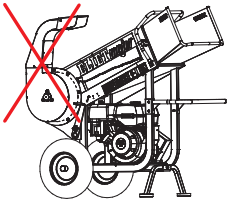

1

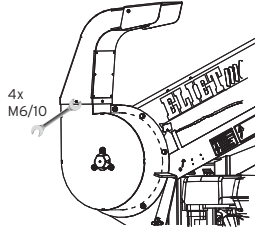

2

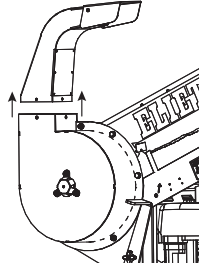

3

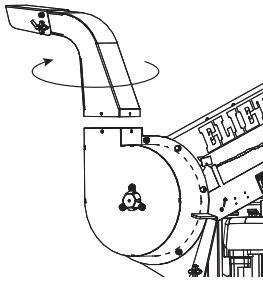

4

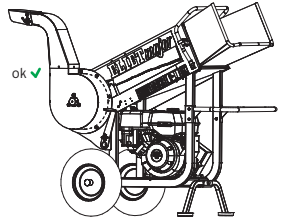
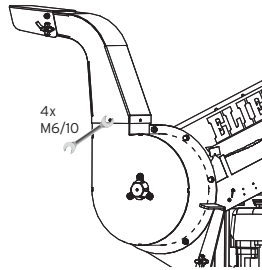

B2 Clearing the turbine

If the turbine is blocked, it can be cleared as follows:

- Turn off the engine.
- Open the shredder chamber by loosening the star screw above the cover plate.
- Release the auxiliary tool at the left side of the machine by removing the star screw.

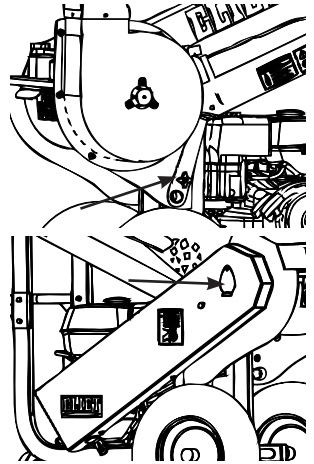

- Open the small cover of the belt protector on the right of the machine.

- Place the sleeve of the auxiliary tool over the end of the axle in the hole of the belt cap and turn the impeller until it can move freely.
- Remove any chips causing the blockage from the turbine.



Caution:

Always remove the auxiliary tool from the axle and return it to its original position before restarting the machine.

B2 Disassembling the blow chute

In case of blockage of the blow chute, or if the machine needs to be transported, the blow chute can be disassembled.

- Turn off the engine.
- Loosen the four bolts from the blow chute. (1)
- Remove the blow chute by sliding it upwards; remove any blockage (2).
- Accurately reassemble all the parts and securely tighten the bolts.

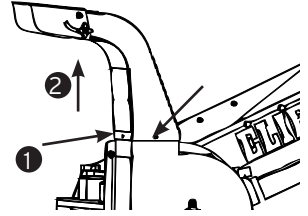

Caution:

Do not start the machine before all the parts have been reassembled into their original position.

B3 List of torques

Bolt head according to DIN 931, 912 ed. Strength		Thread	
		8.8	10.9
Normal thread	M4	3.0	4.4
	M5	5.9	8.7
	M6	10	15
	M8	25	36
	M10	49	72
	M12	85	125
	M14	135	200
	M16	210	310
	M18	300	430
	M20	425	610
	M22	580	820
	M24	730	1050
	M27	1100	1550
M30	1450	2100	
Fine thread	M8 x 1	27	39
	M10 x 1.25	52	76
	M12 x 1.5	89	130
	M14 x 1.5	145	215
	M16 x 1.5	225	330
	M18 x 1.5	340	485
	M20 x 1.5	475	680
	M22 x 1.5	630	900
	M24 x 2	800	1150
	M27 x 2	1150	1650
M30 x 2	1650	2350	

(with friction factor $\leftrightarrow = 0.14$)

B4 Risk analysis

Please find below a list of hazards and risks associated with storing, transporting or operating this shredder. Take good notice of these dangers and avoid risks by following the instructions in the manual. Beware that risks are not limited to the operator: bystanders can be exposed as well. Ensure that bystanders are always at a safe distance.

- Injuries to hands caused by reaching into the inlet opening, beyond the anti-projection flaps.
- Injuries caused by chips flying from the inlet opening after pressing open the anti-projection flaps.
- Risk of serious injuries or death due to release of machine parts (blades, bolts, etc.) as a result of poor checking or maintenance.
- Risk of injuries from flying objects, either from the inlet or outlet side, after a foreign object was entered into the machine (stone, metal, textile, plastic, etc.).
- Injuries from flying chips from the blow chute while the machine is operating.
- Hand injuries from contact with a blade shaft on opening the chipping chamber.
- Cuts to hands when disassembling the blade shaft.
- Cuts due to the blade shaft falling after being disassembled.
- Strangulation or constriction due to loose clothing getting caught in moving parts.
- Injuries caused by the machine tipping due to unsafe transport.
- Risk of fire due to chippings and wood residue blocking the air ducts.
- Air passages and the lungs are prone to irritation from breathing in dust particles produced during operation.
- Noise-induced hearing loss due to insufficient ear protection during operation.
- Bruising or injury when feeding materials, due to the force of the blades on the wood.
- Bruising or injury due to the kick-back of wood when it is introduced in the feeding hopper.
- Mental disturbance or rheumatic disorder due to long periods of shredding without taking breaks.
- Joint pain due to vibration transfer when continuously inserting thick branches.
- Injuries from contact with the blades during unblocking, maintenance or cleaning activities.
- Injury due to a fall while driving over a surface that does not support the weight of the person and the machine.

The list is not exhaustive and only serves the operator's safety.

B5 Warranty conditions

Dear Customer,

We thank you for purchasing an ELIET product. Congratulations on your purchase of this machine which is sure to exceed your expectations and needs over the coming years. At ELIET, we do everything to ensure that our products function properly. That is why your product comes with a two-year warranty.

What is the warranty?

At ELIET, the design and production of our products are subject to strict quality rules. The purpose of these rules is to guarantee a long service life and permanent safety. That is why ELIET is happy to repair any hidden defects or faults during the whole run-in period (i.e. the warranty period) free of charge, provided the prescribed procedure is followed.

Warranty conditions

ELIET's warranty obligations for new machines are governed by the following conditions.

I. Warranty period

The warranty period starts the day the dealer delivers the machine to the customer (maximum one week after the purchase) and expires:

- After two years for private use.
- After twelve months or 100 hours of operation for rental use.
- After twelve months or 100 hours of operation for semi-professional and/or professional use.

To apply for this warranty the customer must register the purchased product with ELIET and complete the registration details on the website:

www.eliyet.eu. If you do not have access to the Internet, please complete the attached registration card and return it to ELIET.

II. The warranty does not apply to the following parts or in the following cases:

- Parts that are subject to wear and tear (e.g. blades, bearings, belts, chains, gearwheels, tyres, bulbs, fuses, etc.) are not covered by the warranty conditions.
- Defects caused by improper use, neglect or consequential damage by an external source (fall, chippings, foreign objects, accident).
- Defects caused by improper maintenance of the machine, hence contrary to the prescribed periodic maintenance.
- Defects caused by improper repairs carried out by others than authorised ELIET dealers or after using other than original ELIET replacement parts.
- Defects caused by making improper changes to the original design of the machine.
- Faults occurring as a result of machine use contrary to the instructions contained in this manual.
- Failure to observe the prescribed warranty procedure or expiry of the warranty period.

- For all problems relating to the engine, please contact an authorised service centre of the engine manufacturer.

III. Procedure

- **Step 1:** On the date of purchase, the customer registers his/her purchase by completing the registration card online at: **www.elieta.eu**. In addition, the enclosed registration card is completed in its entirety on the day of purchase. The first part of the card has to be returned to ELIET within one month. The customer is required to keep all remaining parts of the card along with the purchase invoice for the duration of the warranty period.
- **Step 2:** In the event of a defect, the customer shall have it verified by the authorised ELIET dealer. If the dealer finds a manufacturing defect, he may invoke the warranty under the terms specified.
- **Step 3:** Every warranty application must be accompanied by a fully completed official application form. Dealers may request application forms from ELIET or from an ELIET importer/agent.
- **Step 4:** The dealer orders the parts necessary to perform the repairs. Next, the dealer faxes the order form together with the completed warranty form and a copy of the registration card to ELIET.
- **Step 5:** The warranty form must be stapled to the purchase invoice and sent to ELIET or an ELIET importer/agent.
- **Step 6:** ELIET sends the parts ordered to the dealer under the regular delivery and payment conditions.
- **Step 7:** The defective part will be examined by ELIET's technical department prior to approving or rejecting the warranty. ELIET reserves the right to unilaterally decide whether or not the customer has complied with all the conditions applicable to the one or two-year warranty. Faulty components automatically become the property of ELIET.
- **Step 8:** If a warranty claim is found to be valid, ELIET will credit the warranted parts. Customers are never entitled to a refund of labour costs.

IV. In the event of damage caused by transport:

- All goods are supplied ex factory. Transport risks shall be borne by the customer. ELIET therefore recommends checking the goods for damage on arrival.
- Any damage found must be detailed on the delivery form before signing. Make sure the driver of the transport company puts his signature next to the details about the damage on your copy.
- In the absence of a written and signed statement on the delivery form, the transport insurance company will not accept any liability.
- Claims for damages must be submitted to the carrier and shall include a copy of the delivery form and a covering letter detailing your complaint.
- The damaged machine should be kept in its original condition until the carrier's insurer has performed an examination.

REGISTRATIONCARD ELIET CUSTOMER SERVICE

To be able to claim the full rights to which you are entitled, it is important to register within a month after the date of purchase. Therefore, fill out this registration form and return the first registration card to the ELIET Customer Service. Your purchase should be registered on the ELIET website: www.eliet.be

REGISTRATIEKAART ELIET KLANTDIENST

Om als klant, aanspraak te kunnen maken op waarborg dient men zich binnen de maand na aankoop bij ELIET te registreren. Hiervoor vult u onderstaand document volledig in en stuurt het eerste deel via deze registratiekaart naar de ELIET klantendienst terug. Registreer uw aankoop op de ELIET website: www.eliet.be

CARTE SERVICE

Pour profiter de tous les avantages auxquels vous êtes éligible, il est important de vous inscrire dans le mois suivant l'achat. Complétez ce formulaire et renvoyez la première partie au Service Clientèle ELIET. Enregistrez votre achat sur le site Internet ELIET: www.eliet.be

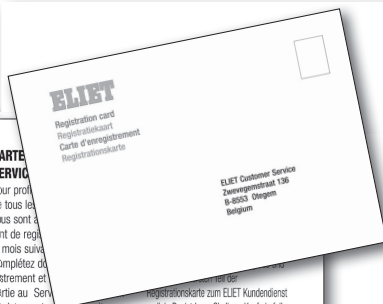

Customer Identity / Klantgegevens / Données du Client / Kundendaten

Name / Naam / Nom / Name		First Name / Voornaam / Prénom / Vorname	
Street / Straat / Rue / Strasse		Nr / Nr / N° / Nr	
		Box / Bus / Boite / App.	
City code / Postnr / Code Postal / Postleitzahl		City / Plaats / Ville / Stadt	
		Country / Land / Pays / Land	
Telephone / Telefoon / Téléphone / Telefon-Nr.		Fax / Fax / Télécopieur / Fax	
E-mail			

Machine identity / Machinegegevens / Données de machine / Daten Maschine

Model / Model / Modèle / Modell		Year of manufacture / Boesjaar / L'année de construction / Baujahr	
Article Code / Artikel code / Code d'article / Artikel-Nr.		Serialnumber / Seriennummer / Numéro de série / Serien-Nr.	
Date / Datum / Date / Datum			
Signature	Stamp of dealer		
Handtekening	Stempel van handelaar		
Signature	Cachet de revendeur		
Unterschrift	Stempel Fachhändler		

I declare that all information that was filled in is correct and truthful. I also declare to have read and understood the operation manual and the warranty conditions. Ik verklaar dat al deze gegevens waarheidsgetrouw werden ingevuld. Hierdoor geef ik te kennen de garantievoorwaarden en handleiding te hebben gelezen en begrepen. Je déclare que tous les données complétées sont correctes et véridiques. Je déclare également d'avoir lu et compris les notices au mode d'emploi et les conditions de garantie. Ich erkläre hiermit, dass alle angegebenen Daten korrekt und wahrheitsgemäß gemacht wurden. Ich erkläre ebenso, dass ich die Garantiebedingungen gelesen und verstanden habe.

Put a crossmark to which application this machine was used. Zet een kruis bij de toepassing waarbij deze machine wordt ingezet. Indiquez avec une croix l'environnement dans lequel la machine a été utilisée. Kreuzen Sie an, für welche Art von Gebrauch die Maschine bestimmt ist.

- Home use / Particulier gebruik / Usage particulier / Private Nutzung
- Professional Landscaping / Hoevermiersbedrijf / Usage Professionnel / Gewerbliche Nutzung
- Forestry / Bosbouw / Forêt / Forstbetrieb
- Public Groundscare / Openbare groenvoorziening / Espaces Verts Public / Öffentliche Grünflächenversorgung
- Rental / Verhuur / Location / Vermietung

Dit document dient binnen de maand na aankoop teruggestuurd te worden naar de ELIET Klantendienst.

This document has to be returned to ELIET Customer Service within a month after purchase.

Remettez ce document au Service après-vente ELIET dans le mois suivant à la date d'achat.

Dieses Dokument muss innerhalb eines Monats nach Kaufdatum an den ELIET Kundendienst zurückgeschickt werden.

